



OWNER'S MANUAL

Part No. Z7100

Instructions for the

JUGS

Combination Pitching Machine



SAVE THIS MANUAL

ATTENTION:
Coaches and Operators of the
Combination (Combo) Pitching Machine:

This manual must be kept with the pitching machine
AT ALL TIMES.

Each coach and/or operator
must read and understand the instructions in this manual
BEFORE USING
the JUGS Combination Pitching Machine.

Call (1-800-547-6843 or 503-692-1635)
if you need additional copies.

Table of Contents

Introduction.....	2
Product Safety Signs and Labels.....	3
Rules for Safe Operation.....	5
Electrical.....	8
Terminology.....	10
Unpacking.....	12
Transporting.....	12
Set Up.....	13
Operating Instructions.....	16
Speed Chart.....	25
Fielding Practice.....	26
Maintenance.....	27
Product Specifications.....	28
Operator Notes.....	29
Warranty Information.....	31

Introduction

Your new JUGS pitching machine has been checked for quality and craftsmanship. Its innovative design is backed by three decades of research, development and manufacturing experience. It has many features designed to make your practices more efficient and enjoyable. Safety, performance and dependability have been given top priority in the design of all JUGS pitching machines, making them easy to operate and maintain. With proper care, your JUGS pitching machine will give you many years of enjoyable service.

At JUGS, we are committed to providing our customers with safe, dependable products. Your comments are always welcome and they help us to continue to be the #1 producer of ball-throwing machines in the world. Call or write to JUGS about your pitching machine.



Product Safety Signs & Labels

Safety Alert Symbols

Safety Alert Symbols indicate **DANGER**, **WARNING** or **CAUTION**. These symbols may be used in conjunction with other symbols or pictographs. Failure to obey a safety warning will result in serious injury to yourself or to others. Always follow the safety precautions to reduce the risk of electric shock and personal injury.

 **DANGER:** Indicates an imminently hazardous situation which, if not avoided, will result in death or serious injury. This signal word is to be limited to the most extreme situations.

 **WARNING:** Indicates a potentially hazardous situation which, if not avoided, could result in death or serious injury.

 **CAUTION:** Indicates a potentially hazardous situation which, if not avoided, may result in minor or moderate injury. It may also be used to alert against unsafe practices.

Product Safety Signs and Labels

The purpose of product safety signs and labels is to attract your attention to possible dangers. The safety symbols, signal words and the explanations with them, deserve your careful attention and understanding. The safety warnings do not by themselves eliminate any danger. The instructions or warnings they give are not substitutes for proper accident prevention measures.

Safety Signs and Labels

Carefully read all safety-sign decals affixed to your JUGS pitching machine before operating it. See some typical examples below.

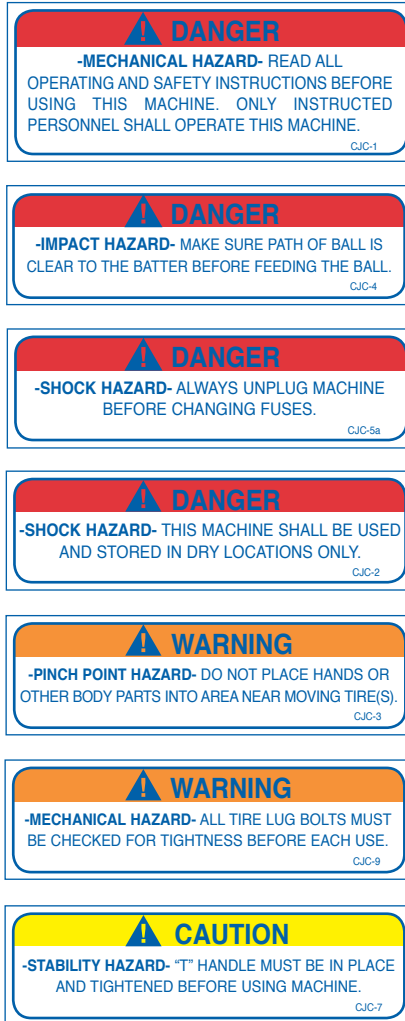

Figure 1

Rules For Safe Operation

- ⚠ WARNING:** JUGS pitching machines are intended for use by operators who are at least 18 years of age and who have been instructed in their use.
- ⚠ WARNING:** Do not attempt to operate this machine until you have read thoroughly and understand completely all instructions, safety rules, machine labels, etc., contained in this manual. Failure to comply can result in accidents involving electric shock or serious personal injury. Save this Owners Manual and review frequently for continuing safe operation, and for instructing others who may use this machine.
- ⚠ WARNING:** Do not connect your pitching machine to a power source until you have assembled and adjusted the machine as described in this manual and have read and understood all precautions and operating instructions in the manual and printed on the machine.

READ THIS MANUAL:

- **Know Your Pitching Machine.** Read the Owner's Manual carefully. Learn the machine's capabilities, features and limitations as well as the specific potential hazards related to this machine.
- **Guard against electrical shock** by preventing body contact with grounded surfaces. For example: radiators, pipes, fences, or other enclosures.
- **Keep the operator's area free of clutter.** Pick up all loose balls around the machine and keep ball supply in a pail, bucket or other suitable container. Cluttered operating areas invite accidents.
- **Do not allow children to operate the pitching machine. You must be at least 18 years of age or older** and instructed in the proper operation, maintenance, care, and storage of this machine before operating it. Close supervision is necessary when this machine is used near children.

Rules For Safe Operation

- **Use the right ball.** Use only JUGS dimpled style, Lite-Flite®, Softie®, one-ounce polyball baseballs, high-quality leather baseballs (9-inch Wilson A1010 equal or better), or tennis balls in this machine.
- **Inspect extension cords periodically** and replace if damaged.
- **Use the proper extension cord.** Make sure your extension cord is in good condition. When using an extension cord, be sure to use one heavy enough to carry the current your machine will draw. An undersized cord will cause a drop in line voltage resulting in loss of power and overheating. A wire gauge size (AWG) of at least 16 is recommended for an extension cord 25 feet or less in length. If in doubt, use the next heavier gauge. The smaller the gauge number, the heavier the cord.
- **Do not abuse the cord.** Never yank cord to disconnect it from receptacle. Keep cord away from heat, oil, and sharp edges. Stay constantly aware of cord location and keep it well away from the rotating tires.
- **Dress properly.** Do not wear loose clothing, gloves, neckties, rings, bracelets, or other jewelry. They can get caught and draw you into the moving parts. Long hair should be tied up and tucked under hats and helmets. Severe physical harm may result if loose clothing, jewelry or hair is caught in rotating tires.
- **Always wear safety glasses and batting helmets while the wheels are rotating.** Debris on the tires can fly off and cause physical harm. Everyday eyeglasses have only impact-resistant lenses; they are NOT safety glasses.
- **Never touch rotating tires.** Do not put hands or fingers into ball feed chute. Hands and fingers should only go to the edge of the chute (or the edge of the sleeve in the case of fly ball or pop-up practice).
- **Inspect machine before every use.** If damaged, have it repaired by a qualified JUGS service technician.
- **Inspect tires before every use.** Be sure tires are free of grit and debris before turning on machine.

Rules For Safe Operation

- **Do not use machine if ON/OFF switch does not work.** In the unlikely event that the switch becomes defective, have it replaced by a qualified JUGS service technician.
- **Keep machine clean, and free of grit and dirt.** With the machine unplugged, use only a clean damp cloth for cleaning. Never use brake fluids, gasoline, petroleum-based products, or any solvents to clean machine.
- **Tighten Lock Knobs and T-Clamps securely** after adjusting trajectory.
- **To protect the operator,** a pitcher's screen must be placed in front of the pitching machine.
- **Only operate and store this pitching machine in a clean, dry location.** Do not use outdoors if it is raining. If machine becomes wet, do not use. A potential shock hazard exists if this machine is used while or after it has been exposed to water. Hand dry surface water from machine with a clean cloth and allow the machine to completely air dry before its next use.
- **Avoid awkward operations and hand positions** where a sudden slip could cause your hand to move into the rotating tires. **ALWAYS** make sure you have good footing and balance.
- **Replacement parts:** All repairs, whether electrical or mechanical, should be made by a qualified JUGS service technician. When servicing, use only JUGS replacement parts.
- **Do not operate this machine under the influence of drugs, alcohol, or any medication.**
- **Stay alert and exercise control.** Watch what you are doing and use common sense. Do not operate this machine when you are tired. Do not rush.
- **Avoid accidental starting when reconnecting to a power supply.** Always turn off machine before disconnecting it from power source. Never leave machine running unattended. Turn the power off. Do not leave machine until tires come to a complete stop.

⚠ WARNING: Do not allow your familiarity with the machine to cause you to be careless. Remember that a careless fraction of a second is enough time to inflict severe injury to yourself or others.

SAVE THIS MANUAL. Refer to it often and use it to instruct other users. Do not loan your pitching machine to anyone who has not been instructed in its use. If you do loan your machine, be sure this manual goes with it.

Electrical

Grounding Instructions

This product must be grounded. If it should malfunction or break down, grounding provides a path of least resistance for electric current to reduce the risk of electric shock. This product is equipped with a cord having an equipment-grounding conductor and grounding plug. The plug must be connected to an appropriate GFCI outlet that is properly installed and grounded in accordance with all local codes and ordinances.

Do not modify the plug provided. If it will not fit the outlet, have the proper outlet installed by a qualified electrician. Improper connection of the equipment-grounding conductor can result in a risk of electric shock. The conductor with insulation having an outer surface that is green with or without yellow stripes is the equipment-grounding conductor. If repair or replacement of the electric cord or plug is necessary, do not connect the equipment-grounding conductor to a live terminal.

Check with a qualified electrician or service personnel if the grounding instructions are not completely understood, or if in doubt as to whether the pitching machine is properly grounded.

Extension Cords

Use only 3-wire 16 AWG or larger grounding type extension cords that have 3-prong grounding plugs and 3-pole receptacles that accept the machine's plug. When using the machine at a considerable distance from a power source, use an extension cord heavy enough to carry the current that the machine will

draw. An undersized extension cord will cause a drop in line voltage, resulting in a loss of power and causing the motor to overheat. Only round jacketed cords listed by Underwriter's Laboratories (UL) should be used.

When working with the machine outdoors, use an extension cord designed for outside use. This is indicated by the letters "WA" on the cord's jacket. Before using the extension cord, inspect it for loose or exposed wires and cut or worn insulation.

⚠ WARNING: Keep the cord away from the rotating tire area. Repair or replace a damaged or worn cord immediately.

Electrical Connection

Your JUGS pitching machine is powered by a 90 volt motor(s). Do not operate this machine on direct current (DC). A substantial voltage drop will cause a loss of power and the motor will overheat. If the machine does not operate when plugged into an outlet, double check the power supply. Your pitching machine will operate under a standard 110 voltage AC outlet. Do not use an adapter with this product.

This machine is intended for use on a circuit that has an outlet like the one shown in Figure 2. It also has a grounding pin like the one shown.

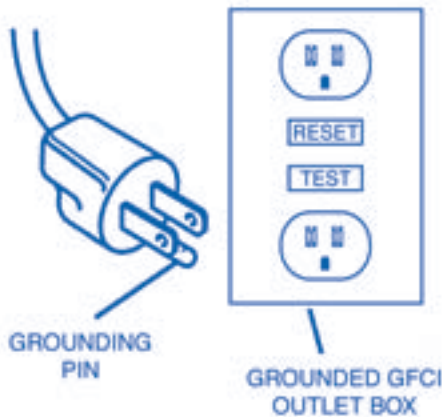

Figure 2

Terminology

COMBO BASEBALL DIAGRAM

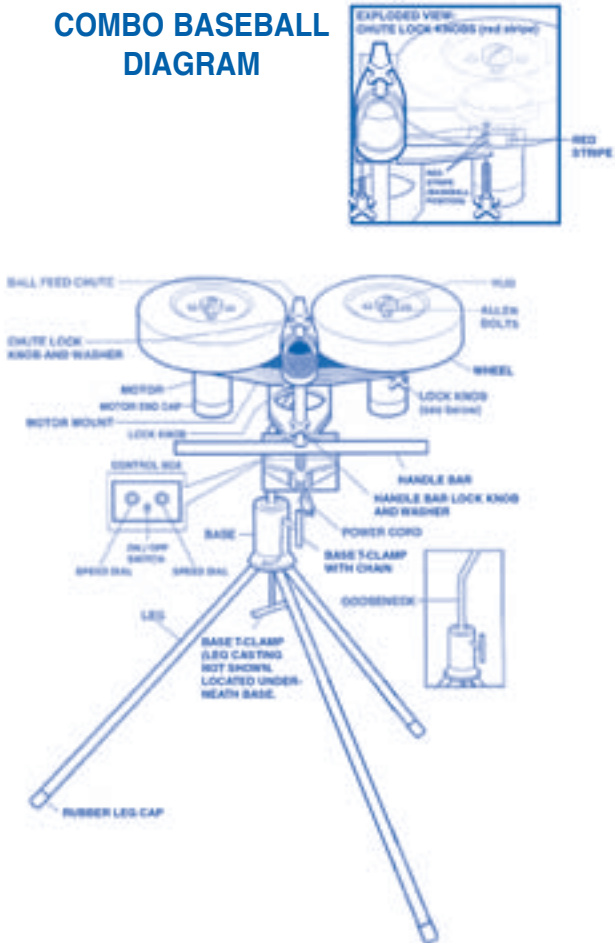

Figure 3

Terminology

COMBO SOFTBALL DIAGRAM

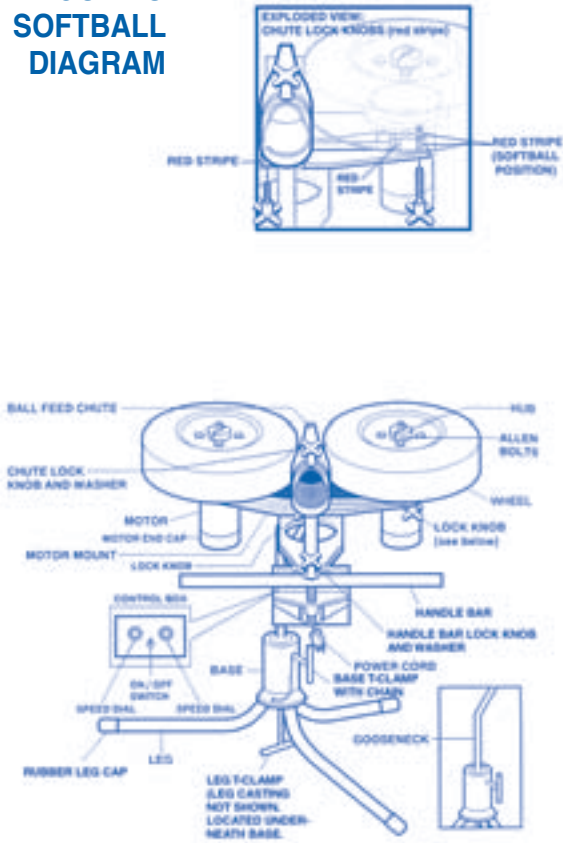

Figure 4

Unpacking

⚠ WARNING: To prevent accidental starting or electrical shock that could cause possible serious injury, assemble all parts to your machine before connecting it to the power supply. The pitching machine should never be connected to a power supply when you are assembling parts, making adjustments, cleaning, servicing, or when not in use.

1. Carefully lift machine from carton and place on level surface.
2. Make sure you have all the parts. (See Figures 3-4.) If any parts are missing, do not operate the machine until the missing parts are replaced. Failure to do so could result in possible serious personal injury.
3. Do not discard the packing materials until you have carefully inspected the machine, identified all the parts, and satisfactorily operated the machine.

NOTE:

If any parts are damaged or missing, do not attempt to plug in the power cord and turn on switch until the damaged or missing parts are obtained and are installed correctly.

Transporting

- To move the pitching machine, slowly tip machine over until tires rest on the ground. Grasp and lift two legs and roll on wheels to new position as you would a wheelbarrow. The JUGS pitching machine will fit in the trunk of a car by removing it's legs.
- Do not roll tires on surfaces that might damage the tire. If the tire becomes deformed, flat, or damaged, it must be repaired or replaced before using the machine. (See tire specifications, Page 28.)

⚠ WARNING: Never leave pitching machine unattended.

Set Up

Setup for Baseball Use:

1. With the tire side down, place the triangular leg clamp in the leg clamp casting. (See Figure 3.)
2. Insert the threaded end of the Leg T-Clamp through the center hole in the leg clamp casting and start the threads.
3. Install one leg in each round hole in the center piece of the leg clamp casting. Tighten the Leg T-Clamp sufficiently to hold the legs in place very snugly.
4. Place rubber leg caps on lower end of legs if JUGS is to be used indoors. The leg caps are not recommended for outdoor use.
5. Lift the pitching machine upright.

IMPORTANT:

Always set up the pitching machine so that the two legs are positioned in front, facing the pitching screen and batter, and one leg facing back toward the operator.

6. Check both speed dials and make sure they are in the full counter-clockwise position (pointer at “0” setting) and the toggle switch is in the **OFF** position.
7. Loosen Handle Bar Lock Knob on top of handle bar and position machine to aim at desired target. Tighten the lock knob. (You will have to practice this targeting so you will know how to set the machine for each pitch.)
8. Slide the right wheel toward the left wheel and position the base ball feed chute assembly so that its two mounting holes line up with the two mounting holes on the pitching machine. See red stripe on the casting for proper hole alignment. Insert and securely tighten the two lock knobs into their appropriate mounting holes. You are now ready to throw baseballs, tennis balls, or poly baseballs.

Set Up

9. Plug heavy-duty, No. 16 gauge three-prong, extension cord into 110-volt GFCI outlet and connect to short cord on pitching machine. Place the pitcher's screen in front of the pitching machine to protect the operator and the pitching machine from batted balls.

For Poly Baseball (Whiffle type only) Use:

Set dials no more than five (5) digits apart. Be sure to reset speed dials 35 digits apart before use with baseballs.

 **WARNING:** Leg and Base T-Clamps must always be tightened securely before throwing pitches. All lock knobs must also be tightened firmly before using the pitching machine.

 **DANGER:** Do not throw pitches without the correct size ball feed chute assembly properly secured.

Setup for Tennis Use:

Tennis balls can be thrown by this machine. Follow setup instructions as outlined above in "Setup for Baseball Use." However, you must first inflate the tires to a pressure of 25 pounds per square inch (psi). Be sure to deflate tires to 16-17 pounds for baseball use and reset the speed dials 35 digits apart before using baseballs.

IMPORTANT NOTE:

See page 24 under "Operation: Tennis Balls" for tennis ball settings **BEFORE** using this machine with tennis balls.

Set Up

To Convert Setup from Baseball to Softball Use

1. Place JUGS upside down, with tires flat on ground or floor and legs pointing upwards.
2. Loosen Leg T-Clamp, which secures legs in place, and remove long legs from sockets.
3. Place the curved ends of the three short legs in sockets so that the distance between the legs is the same. (See Figure 4.)
4. Firmly tighten Leg T-Clamp to hold the legs in place very snugly.
5. Lift the pitching machine upright. Two legs should be facing toward the batter, with one leg facing backward.

To switch from baseball use to softball use or vice versa, you must adjust the distance between the tires and attach the appropriate-size ball-feed chute assembly.

6. To adjust the distance between the tires, loosen and remove the two locking knobs under the right wheel and ball feed chute.
7. After the lock knobs are removed, slide the right wheel away from the left wheel and position the softball feed chute assembly so that its two mounting holes line up with the two mounting holes on the pitching machine. See red stripes on the casting for proper hole alignment. Insert and tighten securely the two lock knobs into their appropriate mounting holes. You are now ready to throw softballs.

NOTE:

To make the mounting of the ball feed chute assembly easier, always insert and secure the lock knob located directly under the ball feed chute first before inserting and securing the lock knob located under the right wheel.

Operation

Your JUGS Combination (Combo) Pitching machine has the versatility to throw baseballs, softballs, tennis balls and polyballs.

1. Operators of JUGS Pitching Machines must wear safety glasses and batting helmets at all times.
2. Check speed dial and make sure it is in the full counter-clockwise position (pointer at "0") and the toggle switch is in the **OFF** position.
3. Plug heavy-duty, No. 16 gauge three-prong, extension cord into 110-volt A/C outlet and connect to short cord on pitching machine. Place the pitcher's screen in front of the pitching machine to protect the operator and the pitching machine from batted balls.
4. Loosen Base T-Clamp and aim machine at desired target. Re-tighten Base Clamp. To adjust trajectory, loosen Handle Bar Lock Knob (Figure 3) and adjust until desired trajectory is attained, then tighten securely. For fine adjustments, loosen lock knob slightly and adjust Handle Bar down, or sideways. (It is normal to throw five or six test balls before arriving at the setting and aim point you desire).
5. Place toggle switch in the ON position. Gradually turn speed dials to desired speed.
6. Have all batters and observers stand well clear of the target as you throw practice balls to adjust trajectory. Tighten Handle Bar securely. Always have the batter stand clear while adjusting your JUGS pitching machine.
7. At the beginning of practice, or after any change in speed, curve, or trajectory, have the batter stand well clear while at least one test ball is thrown to make sure the ball is thrown at the desired target. **If you move the machine for any reason, repeat this process.**
8. Throw balls at speeds the batter can learn to hit. As the batter's skills increase you can throw faster pitches.

Operation

9. When you increase speed of any pitch, you must lower elevation of aim; when you decrease speed, you must increase the aim elevation.
10. Space all pitches approximately six seconds apart. Try to get the batter to regard each pitch as a “separate” pitch and not to be an “automatic” swinger.
11. Always “show” the ball to batter. When you are certain the batter has acknowledged that he or she is ready, set ball in feed chute and release.
Do not drop the ball into the chute.
12. Do not permit more than one or two persons around the pitching machine during its operation.
13. Do not permit the pitching machine to fall on its wheels. This could result in non-warranty damage.
14. Check tightness of all bolts and nuts at regular intervals. If any looseness, vibration, or rattle is noticed, correct immediately before further use.
15. Always turn speed dials to the full counter-clockwise position when throwing is completed or temporarily stopped. Then turn toggle switch to the **OFF** position.

 **WARNING:** A pitching screen must be used to protect the operator and the machine from batted balls.

NOTE:

We suggest that each operator spend a couple of hours experimenting with the JUGS pitching machine. Try many different speed settings. Do not be afraid that any setting you make will harm the pitching machine; however, you should use a wide backstop when experimenting with faster speeds.

Operation

Pitching to Batters

Follow all safety performance instructions in this manual. The following feeding instructions should be used to insure accurate and efficient operation of the JUGS pitching machine.

IMPORTANT PITCHING MACHINE FEEDING INSTRUCTIONS:

- When feeding the machine with leather balls, hold the ball the same way every time. Across the seams is best, especially for curveballs.
- Have all batters and observers stand well clear of the target as you throw test balls to adjust trajectory and aiming point.
- **VERY IMPORTANT:** Before you place the ball in the feeding chute, you should look up at the batter and make absolutely sure the batter is watching you and is ready to receive the pitch. It is **extremely important** that you make sure that the immediate area in front of the pitching machine and the flight path of the ball is clear before you feed the balls into the pitching machine.
- When the batter has taken his/her stance and indicates he or she is ready to hit, hold the ball high in the air where the batter can see the ball. Then bring the ball down to the chute simulating live action so that the batter can time the ball correctly. Set the ball in the feed chute and release. Do not drop the ball into the chute. Watch the ball into the wheels, then look up at the batter. The whole feeding operation should be smooth and without interruption.
- Every batter, after taking his/her stance, as well as between pitches, goes through a personal readiness routine. The ball feeder should adjust the pitch spacing to each batters' habits accordingly. This will assure that the batter is ready to receive the pitch and will also help to simulate live action. The batter can then regard each throw as a separate pitch and avoid becoming an "automatic swinger". Generally speaking, pitches can be spaced between 6 and 10 seconds apart.

Operation

NOTE:

Follow the above feeding instructions when using your JUGS pitching machine for fielding practice as further described in this manual. (See page 26.)

- Out-of-round, soft, mushy, or wet balls will affect accuracy of pitches and must not be used. Mixing different types of balls (leather, rubber, JUGS, etc.) will affect consistency of pitches. For best accuracy, throw only one type of ball at a time.
- Use only JUGS dimpled style, JUGS Pearls®, Lite-Flite®, Softie®, Poly Baseballs, Poly Softballs, high-quality leather baseballs (Wilson A1010 equal or better) or softballs, or tennis balls in this machine.
- Do not permit more than one or two persons around the pitching machine during its operation.

BATTING HELMETS MUST BE WORN AT ALL TIMES.

- Operators of JUGS Pitching Machines must wear safety glasses and batting helmets at all times.

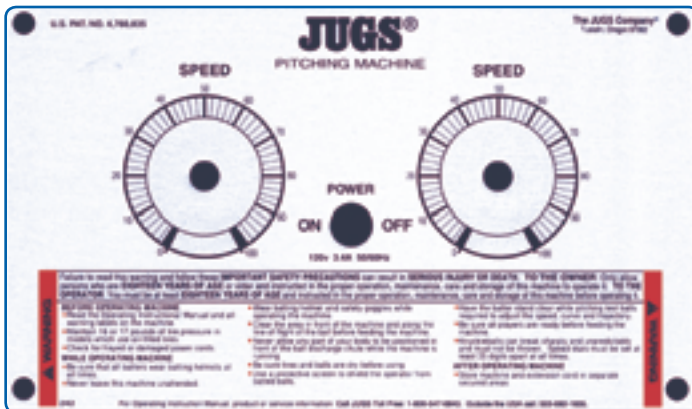

Figure 5. Control Panel

Operation

Throwing Curveballs:

1. Place toggle switch on the Control Panel (Figure 5) in the ON position. Gradually turn right-hand speed dial to full clockwise position. The right wheel will be turning rapidly clockwise and the left wheel will be turning slowly counter-clockwise.
 - a. The above will result in the maximum right-hand curve. Dial settings should be reversed for a left-hand curve.
 - b. For overhand curves, loosen lock knob and tilt pitching machine to a 65 degree angle with faster turning wheel highest.
 - c. To increase the speed of the ball, turn dial for slower turning wheel clockwise.
 - d. To reduce the speed of the ball, or to reduce the amount of curve, turn dial counter-clockwise for the faster turning wheel.
2. Loosen Handle Bar lock knob (Figure 3) and adjust until desired trajectory is attained, then tighten securely. For fine adjustments, loosen lock knob slightly and adjust Handle Bar down, or sideways. (It is normal to throw five or six test balls before arriving at the curve setting and aim point you desire.) Always have the batter and others stand clear while adjusting your JUGS pitching machine and throwing test balls.
3. Be sure to try different settings. For example, when throwing a right-hand curve, set the right hand dial at 70, 75, or 80 and the left hand dial at 30, 35, or 40. Observe the curve and speed of the ball and decide whether the settings used give you the speed and type of curve desired. Most coaches devise a table for the operators of the pitching machine to show what settings to use for any given practice.

NOTE:

The greater the speed differential between the wheels, the greater the curve. Conversely, a smaller differential will result in a smaller curve.

Operation



a. Fastball and overhand curve.



b. Sidearm curves, lefty or righty.



c. Right-handed curves or sliders.



d. Left-handed curves or sliders.

Figure 6

Throwing Straight Balls:

1. A straight fastball can be thrown by setting the pitching machine with one wheel directly on top of the other wheel (Figure 6a) and adjusting the lower wheel to a faster speed than the upper wheel. A minimum of 35 digit differential should be maintained between the speed dial settings of the two wheels at all times.
2. To throw straight fastballs, you must set speed dials 35 digits apart, as shown in Figure 7. For faster straight balls, turn both speed dials up the same amount. For slower straight balls, turn both down the same amount. Always keep the dials 35 digits apart.
3. To throw a **rising fastball**, you must have the **lower wheel** going **faster** than the **higher wheel**. To throw a **sinking fastball**, you must have the **higher wheel** going **faster** than the **lower wheel**.

Operation

Dial Settings for Various Pitches

Use the following diagrams shown below in Figure 7 as guides for using the JUGS Combo pitching machine. Each diagram shows the approximate tilt of the wheels. Numbers represent the speed dial settings.

IMPORTANT: You may have to vary speeds slightly from the examples to get the desired accuracy and consistency.

⚠ WARNING: Equal dial speeds and any dial-speed differential of less than 35 digits may result in a knuckleball. Knuckleballs can be dangerous and **SHOULD NOT** be thrown.

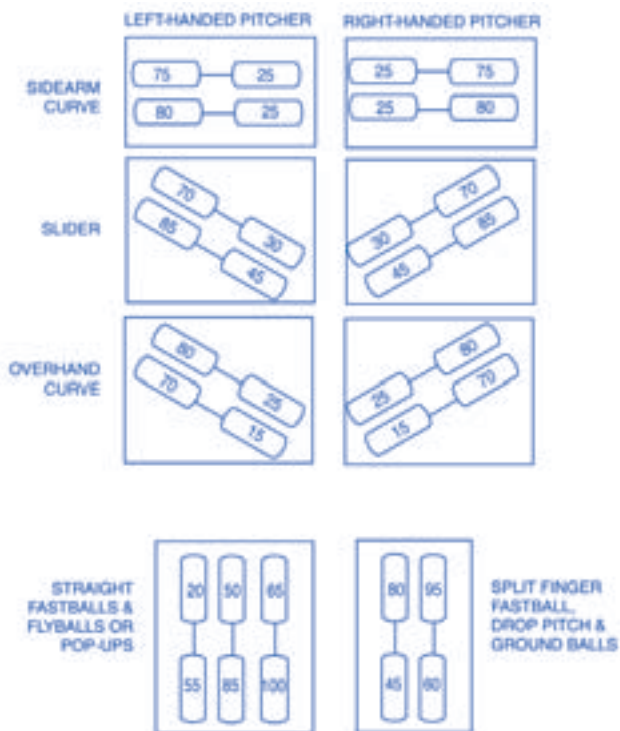



Figure 7

Operation

NOTE: We suggest that each operator spend a couple of hours experimenting with the JUGS pitching machine. (Refer to Table 1, page 25.) You may want to jot down the wheel position and speed dial settings in the space provided on pages 29-30 for future reference. Try many different speed settings. Do not be afraid that any setting you make will harm the pitching machine; however, you should use a wide backstop when experimenting with faster speeds.

- At the beginning of practice, or after any change in speed, curve, or trajectory, have the batter stand well clear while at least one test ball is thrown to make sure the ball is thrown at the desired target. If you move the machine for any reason, repeat this process.
- Throw balls at speeds the batter can learn to hit. As the batter's skills increase you can throw faster pitches.
- When you increase speed of any pitch, you must lower elevation of aim; when you decrease speed, you must increase the aim elevation.
- Do not permit the pitching machine to fall on its wheels. This could result in non-warranty damage.
- Check tightness of all bolts and nuts at regular intervals. If any looseness, vibration, or rattle is noticed, correct immediately before further use.
- Always turn both dials to the full counter-clockwise position when throwing is completed or temporarily stopped. Then turn toggle switch to the **OFF** position.

IMPORTANT: If machine becomes wet during practice, turn off machine immediately, and transport it to a clean, dry location. Dry surface water with a soft, clean cloth and permit machine to completely air dry before next use.

 **WARNING:** A pitching screen must be used to protect the operator and the machine from batted balls.

Operation

Fastpitch Softball

Pitch balls for softball in generally the same manner as baseball, as described on previous pages. For risers, position wheels vertically, with one wheel on top of the other, and set dials the same as fastball settings for baseball.

Slowpitch Softball

Reduce speed accordingly on both dials, always maintaining the minimum 35-digit differential.

Loosen the large hand screw on top of the handle and tilt machine trajectory upward until you achieve the desired arc on the pitch and tighten hand screw.

Tennis Balls

Start with a 60-60 setting for straight balls and 50-70 for curves. (Regular baseball settings are too much for the tennis balls.)

Table 1 [right] is a detailed chart which depicts approximately how fast, in miles per hour, a JUGS Curveball or JUGS Combination pitching machine is throwing, when the dials are set in various positions.

The speeds listed, in miles per hour, are the average speeds of five throws at each of the respective dial settings.

The “speed-to-dial settings” ratio will vary somewhat, depending on the air pressure in the tires, the type of ball used, and the way in which the ball is fed into the pitching machine. This chart will give you a fairly close approximation of the ball speed.

Approximate Speeds, in miles per hour, from the JUGS Cricket Bowling Machine

RIGHT-WHEEL DIAL SETTING																					
	0	5	10	15	20	25	30	35	40	45	50	55	60	65	70	75	80	85	90	95	100
0								27	29	33	36	40	43	46	49	50	54	55	55	56	57
5									29	34	37	41	44	47	50	51	54	56	55	57	58
10										35	39	43	46	48	52	53	55	57	60	61	62
15											41	45	48	50	53	56	59	60	61	62	63
20												47	51	53	56	58	60	62	63	64	64
25													52	55	59	60	62	64	65	65	65
30														57	60	62	65	66	67	68	69
35	27														62	65	68	69	70	71	71
40	29	29														68	70	72	74	75	75
45	33	34	35														74	76	77	78	78
50	36	37	39	41														77	78	80	81
55	40	41	43	45	47														82	83	84
60	43	44	46	48	51	52														86	87
65	46	47	48	50	53	55	57														88
70	49	50	52	53	56	59	60	62													
75	50	51	53	56	58	60	62	65	68												
80	54	54	55	59	60	62	65	68	70	74											
85	55	56	57	60	62	64	66	69	72	76	77										
90	55	56	60	61	63	65	67	70	74	77	78	82									
95	56	57	61	62	64	65	68	71	75	78	80	83	86								
100	57	58	62	63	64	65	69	71	75	79	81	84	87	89							

LEFT-WHEEL DIAL SETTING

WARNING:
 Do not use any speed-dial setting within this light shaded area. They may result in knuckleballs, which can be dangerous and should not be thrown.

Example: If the left wheel is set at 65 and the right wheel is set at 100, the machine will bowl at approximately 89 mph.

Figure 8

Fielding Practice

Fielding Practice

Your JUGS pitching machine can be locked in one position or you can loosen and remove the Base T-Clamp which will allow you to turn the pitching machine freely from side-to-side.



Figure 8: Ground balls



Figure 9: Catcher pop-ups

Grounders (Figure 8)

Position the wheels so they point downward. The greater the downward angle, the bigger the hop will be on the ground ball.

Flyballs and Pop-ups (Figure 9)

Position the wheels pointing upward. The greater the upward angle, the steeper the angle of the flyball or the pop-up will be. For best results, loosen the ball chute lock knob and remove the ball chute. This will then allow you to “push” the ball into the sleeve.

The angle of the flyball, the pop-up, or the grounder, can be adjusted by loosening the handle bar lock knob (power off) and changing the angle of the wheels. Different spins can be put on the ball by changing the speed dial settings.

⚠ WARNING: Keep hands and fingers away from tires and tire side edges of ball chute. When throwing pop-ups, the operator must wear a catcher’s mask. When finished throwing flyballs and pop-ups, always reconnect the ball chute and tighten the ball chute lock knob.

Maintenance

Review the following instructions carefully to maintain maximum accuracy with your JUGS Pitching Machine.

- Maintain tire pressure at 16 to 17 psi (25 psi for tennis balls).

Cleaning

- **Keep machine clean, and free of grit and dirt.** Always use a clean damp cloth when cleaning. Never use brake fluids, gasoline, petroleum-based products, or any solvents to clean machine.
- Periodically, you must clean the tires to help maintain their maximum performance. A dirty tire can easily be distinguished by either a dark ring around the tire surface or when the surface itself has turned yellow and has a very glossy or shiny finish.
- In order to begin cleaning you must first inflate the tires to approximately 17 pounds.
- Using medium grade sandpaper (sometimes an even coarser grade is necessary, depending on the amount of soil buildup) begin to **scrub** the tire surface. This process can be very tedious and may take up to 10 minutes per tire. However, it is necessary to completely remove all foreign substances from the tires to prepare them for better machine performance. You should sand the tires whenever you notice the soil build-up forming. **Always sand tires with the power switch OFF and the machine unplugged.**

Once you complete this operation the tire surface will, in most cases, take on the white color it was originally. Maintaining the tire in this fashion will not only maximize the performance and accuracy of your machine, but it will extend the life of the tire.

Storage

- Always store machine and extension cord in separate, clean, dry secured areas. Cover the machine with a suitable dust cover that does not retain moisture. Do not use plastic.

Product Specifications

JUGS Combination Pitching Machine Product Specifications:

Motor Specifications:

Variable Speed	
Maximum developed horse power	1/4 hp
Volts	90vDC
Amps	3 amps
Hertz	50/60 Hz
RPM (no load)	1900 rpm
Overload protection	yes

Tire Specifications:

Size	4.00/4.80-8
Pressure	16-17 lbs.

Frame Specifications:

Legs	steel tubing
Motor Mount and Leg Clamp Casting	cast aluminum
Ball Feed Chutes	cast aluminum
Overall Height (Baseball)	69 in.
(Softball)	50 in.
Overall Width	47 in.
Overall Weight	145 lbs.
Recommended Generator	Yamaha® EF1000iS
Recommended Balls	JUGS Balls or high-quality leather balls

IMPORTANT:

Servicing requires extreme care and knowledge of the machine and should be performed only by JUGS. For service, we suggest you return the machine to JUGS for repair. Always use original factory replacement parts when servicing.

Warranty

JUGS Sports guarantees that the JUGS® Pitching Machines are well made; of good materials, and workmanship; and agrees that if, within five years after shipment thereof, any part so guaranteed should fail because of defective material or workmanship in its manufacture, the Company will repair or replace such part, free of charge F.O.B. to its factory in Tualatin, Oregon; provided, however, that upon request, the Buyer shall return the allegedly defective part to the Company's factory with transportation charges thereon prepaid. Commercial use of any JUGS® product automatically limits this warranty to 30 days after date of shipment.

This warranty shall not be effective if the equipment has been subject to misuse, negligence or accident, nor if the equipment has been repaired or altered outside of our Tualatin factory in any respect which, in our judgment, affects its condition or operation.

↓ RETURN PERFORATED CARD BELOW TO JUGS SPORTS ↓

Warranty Record

JUGS Serial No. _____ Date Delivered: _____

Model: _____

Name: _____

Address: _____

_____ Zip: _____

Phone: (____) _____

Purchased From: _____

Type of Activity (Youth League, High School, College, etc.): _____

Coach/Manager Name: _____



In the USA and Canada, call toll-free: **1-800-547-6843**

Internationally, call collect: **0-503-692-1635**

Fax us: **1-503-691-1100**

Visit our website: **www.jugssports.com**

Model

Serial No.

Date Delivered

↑ SAVE THIS PORTION FOR YOUR RECORDS ↑

PLACE
STAMP
HERE

JUGS Sports
P.O. Box 365
Tualatin, Oregon 97062

**If you need
more information about
this product
or any other
JUGS product or service,
please contact
the manufacturer:**



In the USA and Canada,
call toll-free:
1-800-547-6843.

For International Orders,
call collect:
0-503-692-1635.

Our fax number is
1-503-691-1100.

Visit our website at
www.jugssports.com.

Se habla español.