

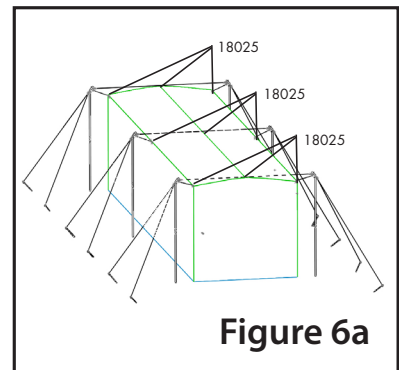

## JUGS® Hit at Home® Backyard Batting Cage Assembly Instructions

Thank you for purchasing the newest addition to the JUGS Batting Cage line up, the Hit at Home® Backyard Batting Cage. This 11' x 11' x 45' net and frame will require an area of approximately 27' x 57'. You will also need a 6' ladder, and two people to assemble.

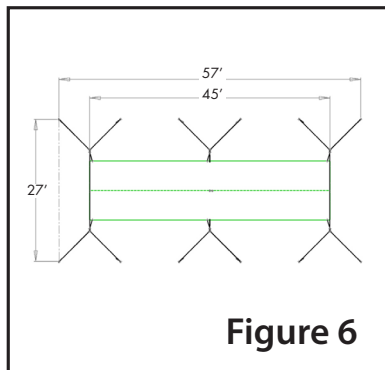
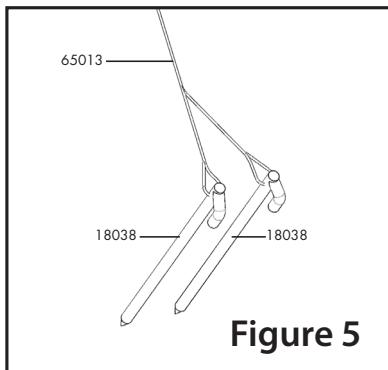
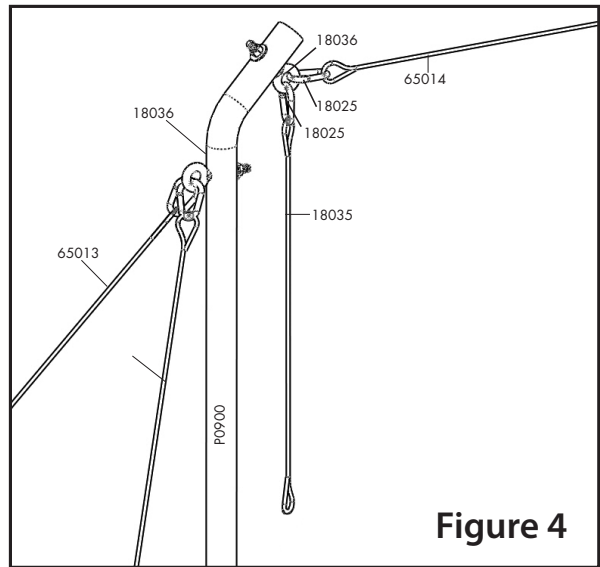
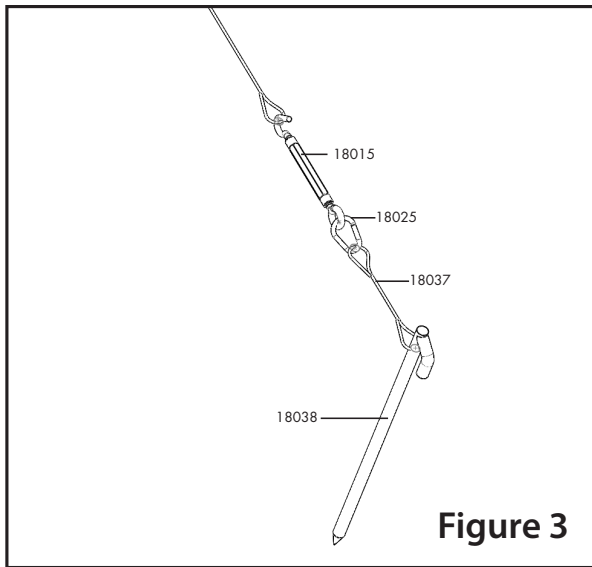
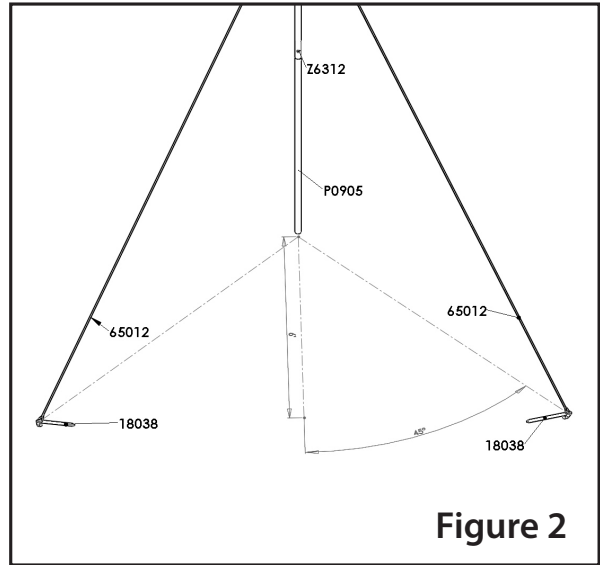
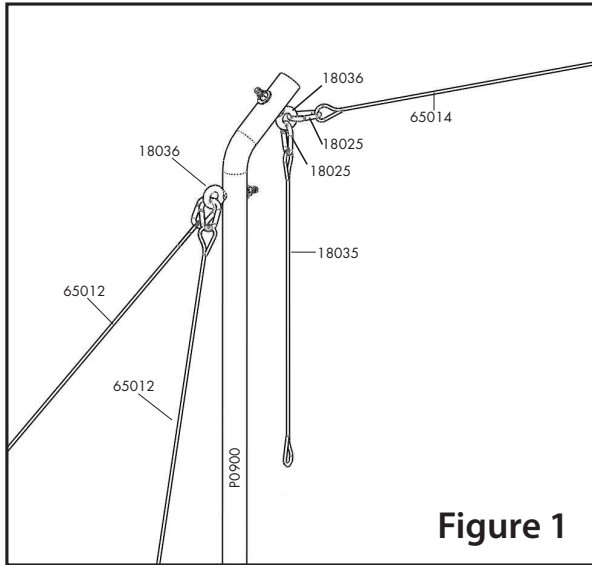

**IMPORTANT!** In the event of inclement weather, simply loosen the three turnbuckles, unhook them from the guy wires, and lay the cage down on the ground. Reverse this procedure to raise the cage.

## Middle Frame Section:

1. Install one eye bolt (18036) onto the top inside and bottom outside of the top uprights (P0900) (**Fig. 1**).
2. Clip one snap ring (18025) onto both ends of the 14' crossbar cable (65014). The 14' crossbar cable comes with two cable hangers (18035) tied in with it.
3. Clip the 14' crossbar cable to the top eye bolts of the top uprights.
4. Clip one snap ring to one end of the four 12' yellow guy-wire cables (65012).
5. Clip these snap rings to the bottom, outside eye bolts of the top uprights.
6. Clip one snap ring onto one end of both 17.5" cable hangers (18035) and clip to the top inside eye-bolts.
7. Insert two bottom uprights (P0905) into two top uprights and snap into place using the buttons (Z6312) already installed in the tubes (**Fig. 2**). The bend at the top of tubes (P0900) should face inward.
8. Use one person to place one upright at one side of the middle of your 56' area and hold it vertical.
9. Make sure there is approximately six linear feet to the outside of the upright for the guy wires (65012).
10. Position the guy-wire cable at 45 degrees from the upright.
11. Insert one stake (18038) through the open loop of one 12' guy-wire cable and pound in stake at an angle. Repeat for the other 12' guy wire.
12. Using the 14' crossbar cable as your guide for the width, place the other upright on the other side and hold it vertical.
13. Make sure there is approximately six linear feet to the outside of the upright for the guy wires (65012).
14. Position one guy-wire cable at 45 degrees from the upright.
15. Insert one stake (18038) through the open loop of one 12' guy wire cable and pound in stake at an angle.
16. Grab a turnbuckle (18015) and unscrew it to create spacing between the bolt heads (**Fig. 3**).
17. Grab a 6" cable hanger (18037) and clip a snap ring (18025) to one end. Snap that end to the eye portion of the turnbuckle.
18. Place the hook of the turnbuckle through the end of the other 12' guy wire.
19. Position the guy-wire cable at 45 degrees from the upright.
20. Insert one stake (18038) through the open loop at the end of the 6" cable hanger, and pound in stake at an angle.

## End Frame Sections:

1. Install one eye bolt (18036) onto the top inside and bottom outside of the top uprights (P0900) (**Fig. 1**).
2. Clip one snap ring (18025) onto both ends of the 14' crossbar cable (65014). The 14' crossbar cable comes with two cable hangers (18035) tied in with it.
3. Clip the 14' crossbar cable to the top eye bolts of the top uprights.
4. Clip one snap ring to one end of the two 12' yellow guy wires (65012) and the single end of the two 12' split cables (65013) (**Fig. 4**).
5. Clip these snap rings to the bottom, outside eye bolts of the top uprights.
6. Clip one snap ring onto one end of both 17.5" cable hangers (18035) and clip to the top inside eye-bolts.
7. Insert two bottom uprights (P0905) into two top uprights and snap into place using the buttons (Z6312) already installed in the tubes (**Fig. 2**). The bend at the top of tubes (P0900) should face inward.
8. Use one person to place one upright at one side of the end frame section.
9. Make sure there is approximately six linear feet to the outside and end of the upright for the guy wires.
10. Position the split cable at 45 degrees from the end upright (the split cables should be placed at the four corners of your cage).
11. Insert one stake (18038) at a time through the ends of the 12' split guy-wire cable (65013) (**Fig. 5**). Pound in stakes at an angle.
12. Grab a turnbuckle (18015) and unscrew it to create spacing between the bolt heads (**Fig. 3**). Place the end frame turnbuckles on the same side as the middle turnbuckle.
13. Grab a 6" cable hanger (18037) and clip a snap ring to one end. Snap that end to the eye portion of the turnbuckle.
14. Place the hook of the turnbuckle through the end of the inside 12' guy wire.
15. Position the guy-wire cable at 45 degrees from the upright.
16. Insert one stake (18038) through the open loop at the end of the 6" cable hanger, and pound in stake at an angle.
17. Using the 14' crossbar cable as your guide for the width, place the other upright on the other side and hold it vertical.
18. Repeat steps 9 through 16 for the other side.

## Net Attachment:

1. Unfold the net lengthwise inside the frame (**Fig. 6 & 6A**).
2. From one end, measure 22.5' to the middle of the net. Clip one snap ring (18025) to the middle rope that runs lengthwise.
3. Clip snap rings to the side ropes that run lengthwise. It is best if you use the same mesh row in which the middle snap ring is located.
4. Using a ladder, clip the middle snap ring to the middle crossbar cable (65014).
5. Clip the left and right snap rings to the cable hangers (18035) on each side.
6. Move to the ends and clip snap rings to the middle, left, and right end ropes.
7. Clip end snap rings to the end crossbar cables.
8. Tighten all three turnbuckles to decrease the sag in the net.



JUGS Sports  
11885 SW Herman Rd.  
Tualatin, OR 97062  
1-800-547-6843  
jugssports.com