



BATTING CAGE NET #8 OUTDOOR INSTALLATION INSTRUCTIONS

#60 Polyethylene and #96 Polyester

NOTE: Drawings are not to scale.

1. Once you assemble them, the end sections will look like this. Insert a short hanging-loop assembly into each of three pre-drilled crossbar holes.

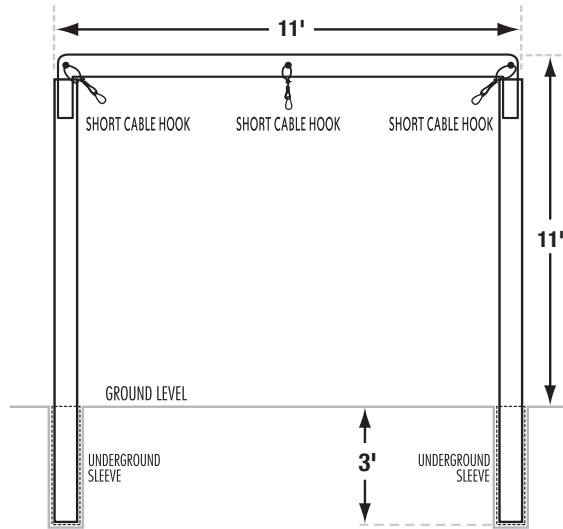

2. Once you assemble them, the two middle sections will look like this. On both, insert a short hanging-loop assembly into the middle pre-drilled crossbar hole and long hanging-loop assemblies into the outside pre-drilled crossbar holes.

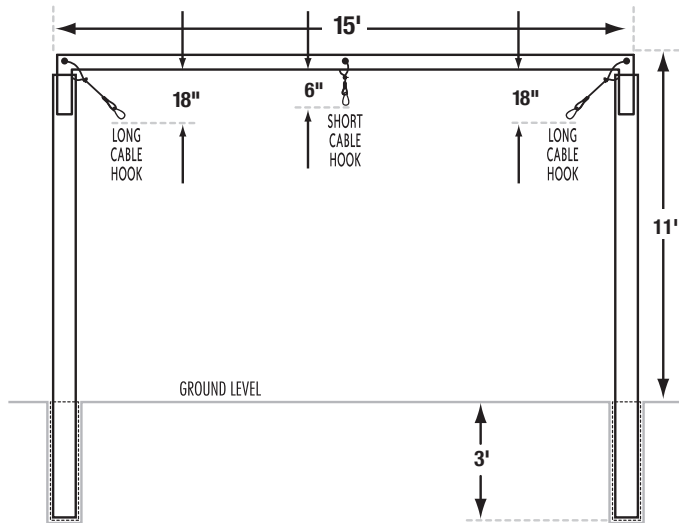

3. OVERHEAD VIEW OF WHERE TO DIG HOLES FOR THE GROUND SLEEVES.

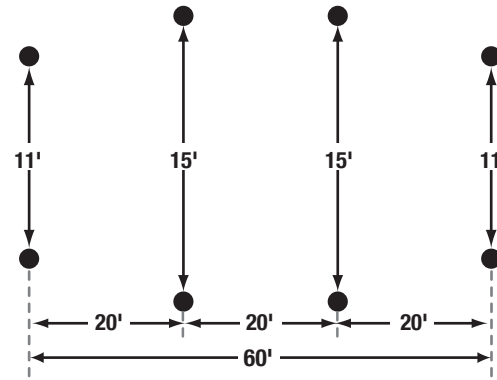

4. SIDE VIEW OF THE FOUR U-SHAPED SECTIONS, COMPLETELY SET UP.

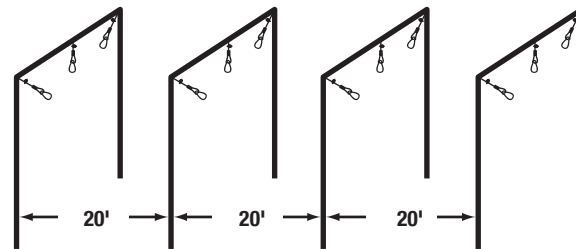

5. SIDE VIEW OF NET, COMPLETELY SET UP

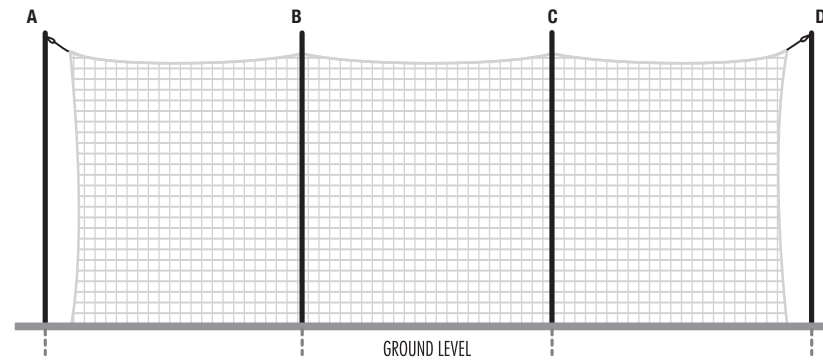

Ropes attach to the hanging-loop assemblies on crossbars A, B, C, and D.

HOW TO SET UP YOUR JUGS OUTDOOR FRAME

1. Check contents to make sure you have all needed parts.

Tubing:

- Eight - 1 1/2" x 14'-long galvanized tubing
- Eight - 2 3/8" x 3'-long galvanized tubing (ground sleeves)
- Two - 1 1/2" x 11'-long galvanized tubing
- Two - 1 1/2" x 15'-long galvanized tubing

Hanging-Loop Assemblies:

- Twelve - hanging-loop assemblies (Four long hanging-loop assemblies and Eight short hanging-loop assemblies)

2. Dig holes and secure the 3' sleeves into the ground. Use concrete to secure your 3' sleeves into the ground.

3. **End Sections:** Insert a short hanging-loop assembly into each of three pre-drilled crossbar holes and secure all with cable clamps.

Middle Sections: Insert a short hanging-loop assembly into each of the middle pre-drilled crossbar holes and long hanging-loop assemblies into the outside pre-drilled crossbar holes and secure all with cable clamps.

4. Slide the middle 15' crossbars into the uprights and fit into the sleeves.

5. Slide the end 11' crossbars into the uprights and fit into sleeves.

You are now ready to attach your netting to the frame.

HOW TO ATTACH YOUR JUGS NET TO THE FRAME

1. Lay your net out under the frame sections. Stretch it out completely from one end to the other.
2. Pick up the net by the nylon rope and attach it to the middle frame sections with the hanging-loop assemblies.
3. After hanging the net on the middle frame sections, making sure that it does not sag more than 1-2', pull the ropes towards the end frames to stretch it out. Attach each rope to the end frame sections with the corresponding hanging-loop assemblies. See Figure 1.
4. Walk completely around the net, pulling and helping the net to stretch into shape. The net will condense inside the box and will need a little help getting back into shape.

NOTE: We at JUGS recommend hanging your batting cage net with a minimum of 18" of netting on the ground. This will provide you with enough net and weight to prevent balls from slipping out underneath the sides and ends of the net.

NOTE: You should not stake the net down or put any type of weight on the net to hold it down. This would cause the net to prematurely wear out because the net would not be allowed to "give" and absorb the batted balls.

Remember: For safety purposes, your net should be at least 2' away from all poles or hard surfaces. That way, none of the batted balls can bounce back and injure someone.

HOW TO ATTACH YOUR HANGING LOOPS TO THE CROSSBARS

1. At each pre-drilled hole on the crossbar, hold the clamp and hanging-loop assembly with one hand and thread the cable through the pre-drilled hole with your other hand.
2. Wrap the cable around the crossbar and thread it back down into the cable clamp.
3. Slide the cable clamp up on the cable and tighten it, leaving one inch of cable hanging below. See Figure 2.

CUSTOM NETTING: FROM FACTORY TO YOU IN LESS THAN 2 WEEKS

All shapes and sizes now available, including: Batting Cage Nets, Backstops, Trapezoid Backstops, Outfield and Foul Ball Netting.

There are 3 Ways for you to get more information and FREE estimates on JUGS Custom Netting:

1. Call JUGS at 1-800-547-6843 and ask for a Net Specialist.
2. FAX your specifications to a Net Specialist at 503-691-1100.
3. E-mail your specifications to info@jugssports.com.

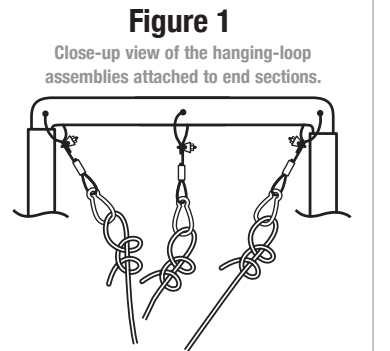

We recommend using a **TWO HALF-HITCH KNOT** when attaching the net ropes to the hanging-loop assemblies.

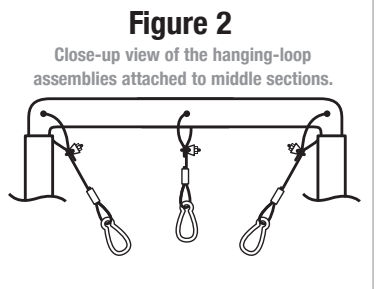

WARNING: Do not leave your net and frame up during extreme weather conditions (high wind, snow), as non-warranty damage may occur.

jugssports.com