



# OWNER'S MANUAL

Instructions for the  
**JUGS**  
**Football-Passing Machine**

Part No. M1700



**SAVE THIS MANUAL**

**ATTENTION,  
Coaches and Operators  
of the Football Passing machine:**

This manual must be kept with the machine  
**AT ALL TIMES.**

Each coach and/or operator  
must read and understand the instructions in this manual  
**BEFORE USING**  
the JUGS Football Passing Machine.

Call 1-800-547-6843 or 503-692-1635  
if you need additional copies.

# Table of Contents

Introduction . . . . .	2
Product Safety Signs and Labels . . . . .	3
Rules for Safe Operation . . . . .	5
Electrical . . . . .	8
Terminology . . . . .	10
Unpacking . . . . .	11
Assembly . . . . .	12
Transporting . . . . .	13
Operating Instructions . . . . .	14
Drills . . . . .	19
Maintenance . . . . .	25
Product Specifications . . . . .	26
Operator Notes . . . . .	27
Warranty Information . . . . .	31

# Introduction



Your new JUGS football machine has been checked for quality and craftsmanship. Its innovative design is backed by three decades of research, development and manufacturing experience. It has many features, designed to make your practices more efficient and enjoyable. Safety, performance and dependability have been given top priority in the design of all JUGS ball throwing machines, making them easy to operate and maintain. With proper care, your JUGS football machine will give you many years of enjoyable service.

At JUGS, we are committed to providing our customers with safe, dependable products. Your comments are always welcome and they help us to continue to be the #1 producer of ball throwing machines in the world. Call or write to JUGS.

# Product Safety Signs & Labels

## Safety Alert Symbols

Safety Alert Symbols indicate **DANGER**, **WARNING** or **CAUTION**. These symbols may be used in conjunction with other symbols or pictographs. Failure to obey a safety warning will result in serious injury to yourself or to others. Always follow the safety precautions to reduce the risk of electric shock and personal injury.

-  **DANGER:** Indicates an imminently hazardous situation which, if not avoided, will result in death or serious injury. This signal word is to be limited to the most extreme situations.
-  **WARNING:** Indicates a potentially hazardous situation which, if not avoided, could result in death or serious injury.
-  **CAUTION:** Indicates a potentially hazardous situation which, if not avoided, may result in minor or moderate injury. It may also be used to alert against unsafe practices.

## Product Safety Signs and Labels

The purpose of product safety signs and labels is to attract your attention to possible dangers. The safety symbols, signal words and the explanations with them, deserve your careful attention and understanding. The safety warnings do not by themselves eliminate any danger. The instructions or warnings they give are not substitutes for proper accident-prevention measures.

# Safety Signs and Labels

Carefully read all safety sign decals affixed to machine before operating your JUGS Football Machine. See some typical examples below.



Figure 1

# Rules For Safe Operation

- ⚠ WARNING:** JUGS Football Machines are intended for use by operators who are at least 18 years of age and who have been instructed in their use.
- ⚠ WARNING:** Do not attempt to operate this machine until you have read thoroughly and understand completely all instructions, safety rules, machine labels, etc. contained in this manual. Failure to comply can result in accidents involving electric shock or serious personal injury. Save this Owners Manual and review frequently for continuing safe operation, and for instructing others who may use this machine.
- ⚠ WARNING:** Do not connect your pitching machine to a power source until you have assembled and adjusted the machine as described in this manual and have read and understood all precautions and operating instructions in the manual and printed on the machine.

## READ THIS MANUAL:

- **Know your football machine.** Read the Owner's Manual carefully. Learn the machine's capabilities, features and limitations—as well as the specific potential hazards related to this machine.
- **Guard against electrical shock** by preventing body contact with grounded surfaces. For example: radiators, pipes, fences or other enclosures.
- **Keep the operator's area free of clutter.** Pick up all loose balls around the machine and keep ball supply in a pail, bucket or other suitable container. Cluttered operating areas invite accidents.
- **Do not allow children to operate the football machine. You must be at least 18 years of age or older** and instructed in the proper operation, maintenance, care and storage of this machine before operating it. Close supervision is necessary when this machine is used near children.

# Rules For Safe Operation

- **Inspect extension cords periodically** and replace them if damaged.
- **Use the proper extension cord.** Make sure your extension cord is in good condition. When using an extension cord, be sure to use one heavy enough to carry the current your machine will draw. An undersized cord will cause a drop in line voltage, resulting in loss of power and overheating. A wire gauge size (AWG) of at least 16 is recommended for an extension cord 25 feet or less in length. If in doubt, use the next heavier gauge. The smaller the gauge number, the heavier the cord.
- **Do not abuse the cord.** Never yank a cord to disconnect it from receptacle. Keep the cord away from heat, oil and sharp edges. Stay constantly aware of cord location and keep it well away from the rotating tires.
- **Dress properly.** Do not wear loose clothing, gloves, neckties, rings, bracelets, or other jewelry. They can get caught and draw you into the moving parts. Long hair should be tied up and tucked under hats and helmets. Severe physical harm may result if loose clothing, jewelry or hair is caught in rotating tires.
- **Any person near this machine must always wear safety glasses and football helmets while the wheels are rotating.** Debris on the tires can fly off and cause physical harm. Everyday eyeglasses have only impact-resistant lenses; they are NOT safety glasses.
- **Never touch rotating wheels.** While pushing the passing/kicking slide, hands and fingers should not go beyond feed-bar bearing.
- **Inspect the machine before every use.** If damaged, have it repaired by a qualified JUGS service technician.
- **Inspect the wheels before every use.** Be sure the wheels are free of grit and debris before turning on the machine.
- **Do not use machine if the ON/OFF switch does not work.** In the unlikely event that the switch becomes defective, have it replaced by a qualified JUGS service technician.



# Rules For Safe Operation

- **Keep the machine clean, and free of grit and dirt.** With the machine unplugged, use only a clean, damp cloth for cleaning. Never use brake fluids, gasoline, petroleum-based products or any solvents to clean the machine.
- **Tighten all T-Clamps securely** after adjusting the trajectory.
- **To protect the operator**, a pitcher's screen must be placed in front of the pitching machine.
- **Operate and store this pitching machine only in a clean, dry location.** Do not use it outdoors if it is raining. If machine becomes wet, do not use it. A potential shock hazard exists if this machine is used while or after it has been exposed to water. Hand-dry surface water from the machine with a clean cloth and allow the machine to completely air dry before its next use.
- **Avoid awkward operations and hand positions** where a sudden slip could cause your hand to move into the rotating wheels. ALWAYS make sure you have good footing and balance.
- **Use only JUGS technicians and JUGS replacement parts.** All repairs, whether electrical or mechanical, should be made by a qualified JUGS service technician. When servicing, use only JUGS replacement parts.
- **Do not operate this machine under the influence of drugs, alcohol, or any medication.**
- **Stay alert and exercise control.** Watch what you are doing and use common sense. Do not operate this machine when you are tired. Do not rush.
- **Avoid accidental starting when reconnecting to a power supply.** Always turn off the machine before disconnecting it from a power source. ***Never leave the machine running unattended.*** Turn the power off. Do not leave the machine until the wheels come to a complete stop.
- **Always unplug the machine when it is not in use.**

**⚠ WARNING:** Do not allow your familiarity with the machine to cause you to be careless. Remember that a careless fraction of a second is enough time to inflict severe injury on yourself or others.

**SAVE THIS MANUAL.** Refer to it often and use it to instruct other users. Do not loan your football machine to anyone who has not been instructed in its use. If you do loan your machine, be sure this manual goes with it.

# Electrical

## Grounding Instructions

This product must be grounded. If it should malfunction or break down, grounding provides a path of least resistance for electric current to reduce the risk of electric shock. This product is equipped with a cord having an equipment-grounding conductor and grounding plug. The plug must be connected to an appropriate GFCI outlet that is properly installed and grounded in accordance with all local codes and ordinances.

Do not modify the plug provided. If it will not fit the outlet, have the proper outlet installed by a qualified electrician. Improper connection of the equipment-grounding conductor can result in a risk of electric shock. The conductor with insulation having an outer surface that is green with or without yellow stripes is the equipment-grounding conductor. If repair or replacement of the electric cord or plug is necessary, do not connect the equipment-grounding conductor to a live terminal.

Check with a qualified electrician or service personnel if the grounding instructions are not completely understood or if you are in doubt as to whether the pitching machine is properly grounded.

## Extension Cords

Use only 3-wire 16 AWG or larger grounding-type extension cords that have 3-prong grounding plugs and 3-pole receptacles that accept the machine's plug. When using the machine at a considerable distance from a power source, use an extension cord heavy enough to carry the current that the machine will

draw. An undersized extension cord will cause a drop in line voltage, resulting in a loss of power and causing the motor to overheat. Only round-jacketed cords listed by Underwriter's Laboratories (UL) should be used.

When working with the machine outdoors, use an extension cord designed for outside use. This is indicated by the letters "WA" on the cord's jacket. Before using the extension cord, inspect it for loose or exposed wires and cut or worn insulation.

**⚠ WARNING:** Keep the cord away from the rotating tire area. Repair or replace a damaged or worn cord immediately.

## Electrical Connection

Your JUGS pitching machine is powered by a 90 volt motor(s). Do not operate this machine on direct current (DC). A substantial voltage drop will cause a loss of power and the motor will overheat. If the machine does not operate when plugged into an outlet, double check the power supply. Your pitching machine will operate under a standard 110 voltage AC outlet. Do not use an adapter with this product.

This machine is intended for use on a circuit that has an outlet like the one shown in figure 2. It also has a grounding pin like the one shown.

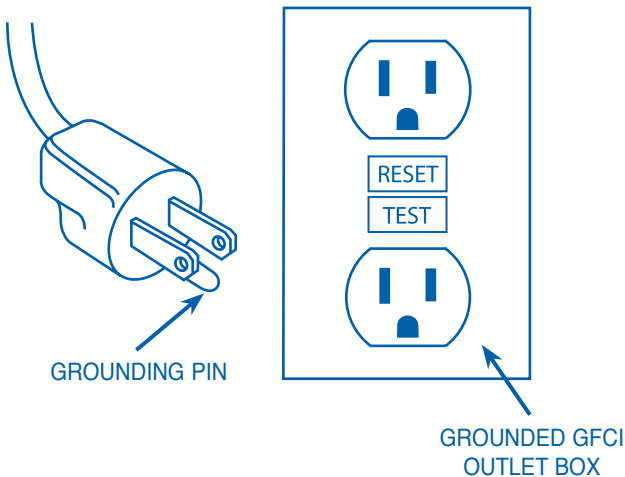

# Terminology

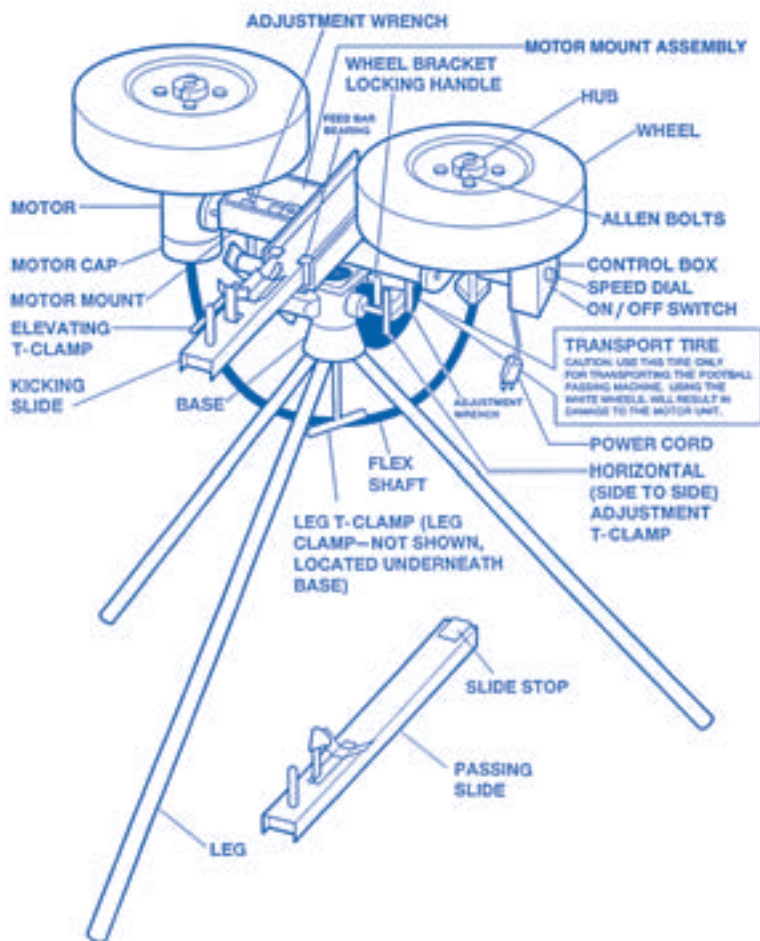

Figure 3

# Terminology

**⚠ WARNING:** To prevent accidental starting or electrical shock that could cause possible serious injury, assemble all parts to your machine before connecting it to the power supply. The pitching machine should never be connected to a power supply when you are assembling parts, making adjustments, cleaning, servicing or when not in use.

1. Carefully lift the machine from its carton and place it on a level surface.
2. Make sure you have all the parts (see figure 3). If any parts are missing, do not operate the machine until the missing parts are replaced. Failure to do so could result in possible serious personal injury.
3. Do not discard the packing materials until you have carefully inspected the machine, identified all the parts and satisfactorily operated the machine.

**NOTE:**

If any parts are damaged or missing, do not attempt to plug in the power cord and turn on the switch until the damaged or missing parts are obtained and are installed correctly.

# Assembly

1. With the tire-side down, place the triangular leg clamp in the leg clamp casting (see figure 3).
2. Place the lock washer on the threaded end of the Leg T-Clamp,
3. Insert the threaded end of the Leg T-Clamp through the center hole in the leg-clamp casting and start the threads.
4. Install one leg in each round hole in the center piece of the leg clamp casting. Tighten the Leg T-Clamp sufficiently to hold the legs in place very snugly.
5. Place the rubber leg caps on the lower end of the legs if your JUGS machine is to be used indoors. The leg caps are not recommended for outdoor use.
6. Lift the football machine upright and onto its legs.

## **IMPORTANT:**

Always set up the machine so that two legs are positioned in front, facing the target, and one leg facing back toward the operator.

1. Check the speed dial and make sure it is in the full counter-clockwise position (pointer at the "0" setting) and the toggle switch is in the OFF position.
2. Plug a heavy-duty, no.16-gauge three-prong, extension cord into a 110-volt GFCI outlet and connect it to the short cord on the pitching machine.
3. Loosen the Horizontal T-Clamp and position the machine to aim at the desired target. Re-tighten the T-Clamp. Adjust the desired height of the machine by using the Elevating T-Clamp. (You will have to practice this targeting to learn how to set the machine for each pass).

# Transporting

The JUGS Football Passing Machine can be moved quickly and easily by using the black Transport Tire attachment.

1. Make sure your JUGS machine is turned off and the wheels are NOT spinning.
2. Remove the Kicking or Passing Slide from the machine.
3. Loosen the Elevating T-Clamp and rotate the Motor Mount Assembly completely back. Tighten the Elevating T-Clamp.
4. Place the black Transport Tire attachment into its proper place on the front of the machine as shown below.



5. Raise the black Transport Tire attachment into the moving position (the highest position possible). **Tighten the Lock Handle securely.**
6. Slowly tip the machine over, **onto the black tire**. Lift up the legs and push the wheelbarrow.
  - **Do not use the white ball-throwing wheels for moving this machine.**



To remove the black Transport Tire attachment, completely unscrew and remove the Lock Handle and lift black Transport Tire attachment away from the machine.

**⚠ WARNING:** Never leave a pitching machine unattended.

# Operation

## GENERAL OPERATING INSTRUCTIONS

The following instructions are detailed steps you should follow to get the most out of this football machine.

### IMPORTANT:

When the right wheel is mentioned, it is the wheel on your right when you are standing behind the machine, as shown in figure 4.

When the left wheel is mentioned, it is the wheel to your left when you are standing behind the machine.



Figure 4

1. Be sure the control switch is in the “OFF” position.
2. To adjust the wheel for passing and kicking, loosen the Adjustment Wrenches that lock the wheels in place (see figure 5).



Figure 5

**⚠ WARNING:** The horizontal-adjustment and T-Clamps must always be tightened securely before throwing passes. All lock knobs and T-Clamps must also be tightened firmly before using the Football machine.



# Operation



Figure 6. Control Box with Speed Dial

**⚠ CAUTION:** Football Helmets must be worn at all times.

## **IMPORTANT:**

Always throw balls at speeds suitable for the age and skill level of the receiver. Throws or kicks which are too fast for the receiver will be counterproductive and dangerous.

# Operation

Follow all safety performance instructions in this manual. The following ball-feeding instructions should be used to insure accurate and efficient operation of the JUGS Football Machine.

## Important Football Machine Feeding Instructions:

1. Hold the ball seams (leather stitching) up every time.
2. At the beginning of practice, or after any change in speed or trajectory, have the receivers stand well clear while a sufficient number of test balls are thrown to make certain the machine is properly aimed at the intended target. If you move the machine for any reason, repeat this process.
3. Do not permit more than one or two people around the football machine during operation.
4. **VERY IMPORTANT:** Before you place the ball on the passing or kicking slide, you should look up at the receiver and make absolutely sure he or she is watching you and is ready to receive the ball. It is extremely important that you make sure that the immediate area in front of the football machine and the flight path of the ball is clear before you feed the balls into the football machine.
5. When the receiver has indicated he or she is ready, hold the ball high in the air where the receiver can see the ball. Then bring the ball down to the slide. Watch the ball as it slides toward the wheels, then look up at the receiver. The whole feeding operation should be smooth and without interruption.
6. Throw balls at speeds at which players can effectively learn the desired skills. Balls thrown too hard will be counterproductive and dangerous. You can adjust the speed as the player's skills increase. Generally speaking, passes can be timed about 6 seconds apart.
7. Deformed, soft, mushy, or wet balls will affect accuracy of tosses and must not be used. Mixing different types of balls (leather, rubber, etc.) will affect consistency of throws or kicks. Throw only one type of ball at a time.

# Operation

**NOTE:** We suggest that each operator spend a couple of hours experimenting with the JUGS Football Machine. (You may want to jot down the wheel position and speed-dial settings in the space provided on page 27, for future reference.) Try many different speed settings. Do not be afraid that any setting you make will harm the machine; however, you should use a wide backstop when experimenting with faster speeds.

## Throwing Right-Handed Spirals

1. To throw a right-handed spiral, tilt the left wheel to its maximum forward position and the right wheel to its maximum backward position (see figure 7).
2. Make sure you lock both handles after you have shifted the wheels to the proper positions (see figure 8).



Figure 7



Figure 8

3. Follow these four steps for passing or punting spirals:
  - a. Place the ball into the cone.
  - b. Hold the ball in place with one hand placed lightly on the top.
  - c. Push the plunger towards the wheels.
  - d. The ball will spiral smoothly towards the target.

# Operation

## Throwing Footballs End Over End (non spirals)

Use the following to set up JUGS to throw end-over end, to practice kick-off returns or field goal attempt returns.

1. Remove the nut and bolt on the front of the Passing Slide assembly (figure 9).
2. Take off the Passing Slide assembly, by removing the cone-shaped piece (figure 10).
3. Insert the Kicking Slide assembly. Note that the Kicking Slide assembly has no cone shaped piece (figure 11).
4. Replace the nut and bolt on the front of the assembly.
5. Tilt the wheels so they are exactly level. The wheels will be parallel to the ground when you are throwing end-over-end (figure 12). There are black marker lines, underneath each tire, to help you line up the tires so they are exactly parallel to the ground (figure 13).
6. Follow these 5 steps for throwing footballs end-over-end:
  - a. Make sure you are using the “kicking” slide.
  - b. Place the ball onto the slide as shown in figure 14. The ball must be positioned at a 45-degree angle to get perfect end-over-end tosses.
  - c. Hold the top of the ball with one hand.
  - d. Push the slide towards the tires.
  - e. The ball will travel in an end-over-end fashion towards your target.



Figure 9



Figure 10



Figure 11



Figure 12



Figure 13



Figure 14

# Drills

You may want to develop some of your own drills which utilize the capabilities of your JUGS Football Machine.

Charlie McClendon and his staff, at Louisiana State University, have come up with the following drills utilizing JUGS. Receivers, linebackers and secondary men get a real chance to develop using these and similar drills.

## Linebacker's Interception Drill

(Figure 15)

The players line up in single file, twenty yards directly in front of the machine. Start out by spiraling the ball high so they will have to jump for it and then go to the bad-ball drill.



Figure 15

## Linebacker's Distraction Drill

(Figure 16)

Two players face each other, approximately 25 yards away from JUGS. They put their hands up and try to distract the linebacker from making the interception.



Figure 16

## Linebacker's Underneath Cover Drill

(Figure 17)

Have the receivers run a wide route. The linebacker must sprint for coverage without getting in a chase position on the receiver.



Figure 17

## Linebacker's Circle-Coverage Drill

(Figure 18)

The receivers circle from ten to fourteen yards deep, then slice in either direction. The linebacker must turn and sprint to the coverage area without turning his back to pass or for "back peddling."



Figure 18

# Drills

## Linebackers' Zone Coverage Drill (Figure 19)

As the linebackers sprint to the correct zone, spiral the ball in the general area of any linebacker.

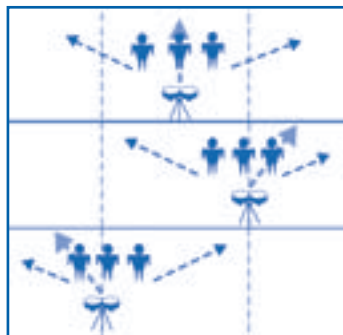

Figure 19

## Defensive-Backs' Interception Drill (Figure 20)

JUGS can spiral the ball between shields for three different types of interception drills: (1) before, (2) during and (3) after the players come through.

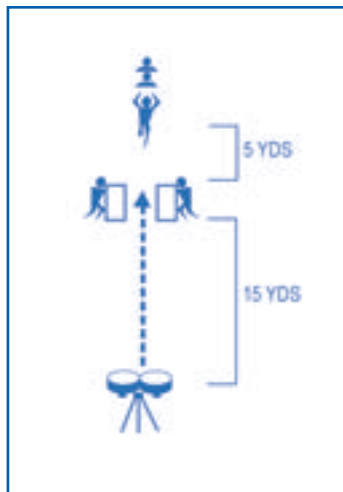

Figure 20

## Defensive-Backs' Distraction Drill (Figure 21)

On command, the defensive back moves toward the player with the dummy and as he moves in front and makes the interception, he is bumped with the dummy.

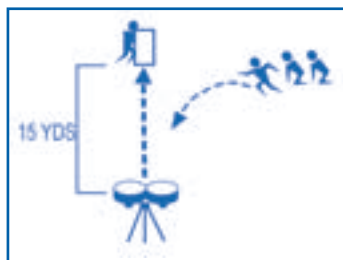

Figure 21

# Drills

## Defensive-Backs' Over-the-Head Drill

(Figure 22)

Defensive backs are lined up facing away from JUGS. Players run with their backs to JUGS and intercept the ball coming over their heads.



Figure 22

## Defensive-Backs' Post Coverage Drill

(Figure 23)

Backs alternate sides and practice coverage on long-post patterns. All sorts of distances and arcs can be put on the passed ball.



Figure 23

## Defensive-Backs' Cross Field Drill

(Figure 24)

Two players, facing each other hold blocking dummies as shields. The other players must run through the shields from the side and intercept the ball.



Figure 24

## Defensive-Backs' Hash Mark-to-Hash Mark Drill

(Figure 25)

A player runs directly at JUGS then cuts for an interception as the coach signals and spirals the ball to one hash mark or the other.

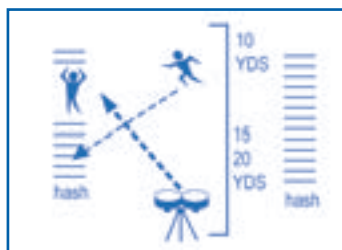

Figure 25

# Drills

## Pass-Receiver's' Sideline Drill

(Figure 26)

Various speeds and arcs can be put on the ball for sideline pass pattern practice. The coach can be positioned to watch for proper footwork.

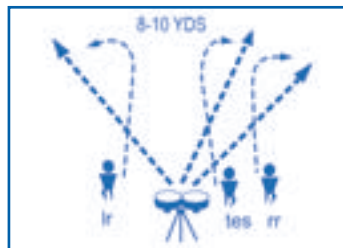

Figure 26

## Pass-Receiver's' Circle Drill

(Figure 27)

On command, the pass receiver circles outside the dummies and catches the ball between the two. Alternate sides.

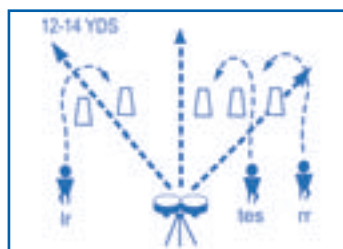

Figure 27

## Pass-Receiver's' Quick-Post Drill

(Figure 28)

JUGS spirals passes in rapid succession for running quick-post patterns. Good for tight-ends splitting the seams.

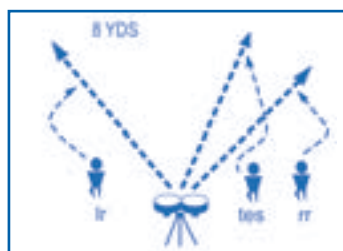

Figure 28

## Pass-Receiver's' Flat-Pass Drill

(Figure 29)

Receivers can practice cuts from a tight or split position, both short and long.

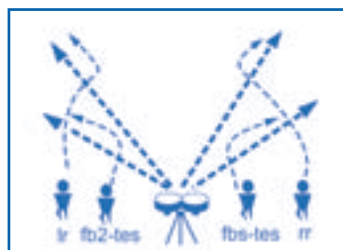

Figure 29



# Drills

## Pass-Receiver's' Post-Pattern Drill (Figure 30)

Position the pass so that receivers sprint out for it. Keep all receivers running in a circle.

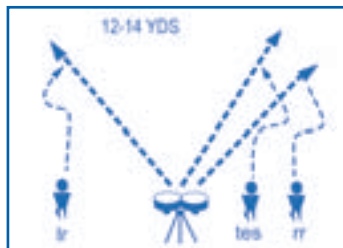

Figure 30

## Pass-Receiver's' Stop-and-Go Drill (Figure 31)

Receivers can develop timing and footwork since JUGS will send the same pass time after time.

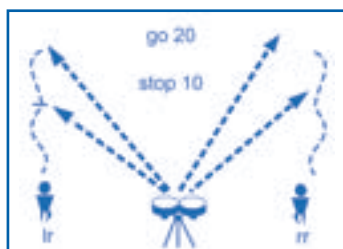

Figure 31

## Pass-Receiver's' Hash-Mark-to-Hash-Mark Drill (Figure 32)

Punt first to one hash mark and then to the other, making receivers sprint to catch the ball.

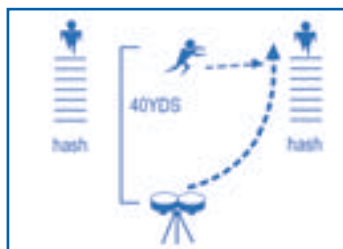

Figure 32

## Pass-Receiver's' "Bloop"-Ball Drill (Figure 33)

When machine tires are tilted and the ball is fed through the tires, it will sidewind or "bloop." Receivers gain practice on wobbly kicks.



Figure 33

# Drills

## Punt Receivers' Communication Drill (Figure 34)

Pass the ball directly between two receivers so that they must communicate.

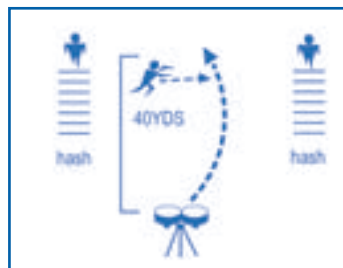

Figure 34

# Maintenance

**Review the following instructions carefully to maintain maximum accuracy with your JUGS Football Machine.**

**Maintain tire pressure at 16 to 17 psi.**

## Cleaning

- Keep the machine clean, and free of grit and dirt. Always use a clean damp cloth when cleaning. Never use brake fluids, gasoline, petroleum-based products, or any solvents, to clean the machine.
- Periodically, you must clean the wheel to help maintain its maximum performance. A dirty wheel can easily be distinguished by either a dark ring around the wheel surface or when the surface itself has turned yellow and has a very glossy or shiny finish.
- Using medium grade sandpaper (sometimes an even coarser grade is necessary, depending on the amount of soil buildup), begin to scrub the tire surface. This process can be very tedious and may take up to 10 minutes per tire. However, it is necessary to completely remove all foreign substances from the tires to prepare them for better machine performance. You should sand the tires whenever you notice the soil build-up forming. Always sand tires with the power switch OFF and the machine unplugged.

Once you complete this operation, the tire surface will, in most cases, take on the white color it was originally. Maintaining the tire in this fashion will not only maximize the performance and accuracy of your machine, but it will extend the life of the tire.

## Storage

- Always store the machine and extension cord in separate, clean, dry, secured areas. Cover the machine with a suitable dust cover that does not retain moisture. Do not use plastic.

# Product Specifications

## JUGS Football Machine Product Specifications:

### Motor Specifications:

Variable Speed	
Maximum-developed horsepower .....	1/4 hp
Volts .....	90vDC
Amps .....	2.8 amps
Hertz .....	50/60 Hz
RPM (no load) .....	1900 rpm
Overload protection .....	yes

### Wheel Specifications:

Size .....	4.00/4.80-8
Pressure .....	16-17 psi

### Frame Specifications:

Legs .....	steel tubing
Motor-Mount and Leg-Clamp Casting .....	cast aluminum
Slide .....	cast aluminum
Overall Height .....	56 in.
Overall Width .....	39 in.
Overall Weight .....	130 lbs.
Recommended Generator .....	Yamaha® EF1000iS
Recommended Balls .....	Wilson Leather Football

### IMPORTANT:

Servicing requires extreme care and knowledge of the machine and should be performed only by JUGS. For service, we suggest you return the machine to JUGS for repair. Always use original factory replacement parts.











# Warranty

JUGS Sports guarantees that the JUGS® Pitching Machines are well made; of good materials, and workmanship; and agrees that if, within five years after shipment thereof, any part so guaranteed should fail because of defective material or workmanship in its manufacture, the Company will repair or replace such part, free of charge F.O.B. to its factory in Tualatin, Oregon; provided, however, that upon request, the Buyer shall return the allegedly defective part to the Company's factory with transportation charges thereon prepaid. Commercial use of any JUGS® product automatically limits this warranty to 30 days after date of shipment.

*This warranty shall not be effective if the equipment has been subject to misuse, negligence or accident, nor if the equipment has been repaired or altered outside of our Tualatin factory in any respect which, in our judgment, affects its condition or operation.*

↓ RETURN PERFORATED CARD BELOW TO JUGS SPORTS ↓

## Warranty Record

JUGS Serial No. \_\_\_\_\_ Date Delivered: \_\_\_\_\_

Model: \_\_\_\_\_

Name: \_\_\_\_\_

Address: \_\_\_\_\_

\_\_\_\_\_

\_\_\_\_\_ Zip: \_\_\_\_\_

Phone: (\_\_\_\_) \_\_\_\_\_

Purchased From: \_\_\_\_\_

Type of Activity (Youth League, High School, College, etc.): \_\_\_\_\_

Coach/Manager Name: \_\_\_\_\_



In the USA and Canada, call toll-free: **1-800-547-6843**

Internationally, call collect: **0-503-692-1635**

Fax us: **503-691-1100**

Visit our website: **[www.jugssports.com](http://www.jugssports.com)**

---

Model

---

Serial No.

---

Date Delivered

**↑ SAVE THIS PORTION FOR YOUR RECORDS ↑**

---

---

---

---

PLACE  
STAMP  
HERE

**JUGS Sports**  
**P.O. Box 365**  
**Tualatin, Oregon 97062**



**If you need  
more information about  
this product  
or any other  
JUGS product or service,  
please contact  
the manufacturer:**



In the USA and Canada,  
call toll-free:  
1-800-547-6843.

For International Orders,  
call collect:  
0-503-692-1635.

Our fax number is  
1-503-691-1100.

Visit our website at  
[www.jugssports.com](http://www.jugssports.com).

Se habla español.