

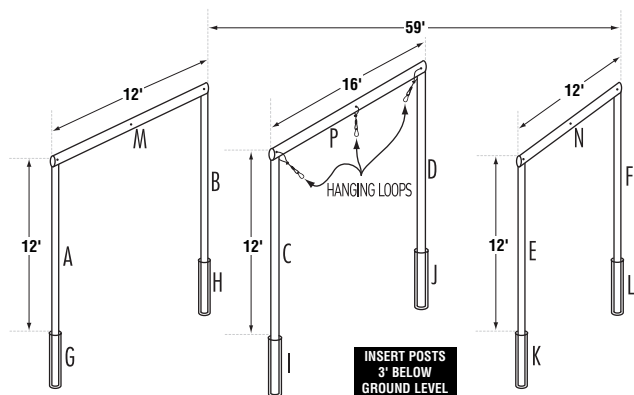

# Batting Cage Net #10 Outdoor **OPTIONAL INSTALLATION KIT** Instructions

119-lb. and 191-lb. Breaking-Strength Knotted-Nylon Twine • One-Year Guarantee, Available in Dark Green Only

**1. Here is a drawing of how your frame will look before you set up your cables and hang up your net.**



**2. Here is a list of the type of tubing and how many of each you will need to install your JUGS Batting Cage Net.**

- Six 1 7/8 galvanized tubing – 15' – A, B, C, D, E and F in drawing.
- Six 2 3/8 galvanized tubing – 3' long – G, H, I, J, K, L. These are underground “sleeves.”
- Two 1 5/8 galvanized tubing – 12' long – M and N. These are “end section” crossbars.
- One 1 5/8 galvanized tubing – 16' long – P. This is the middle crossbar.

**3. TOP VIEW OF TUBING INSTALLATION**

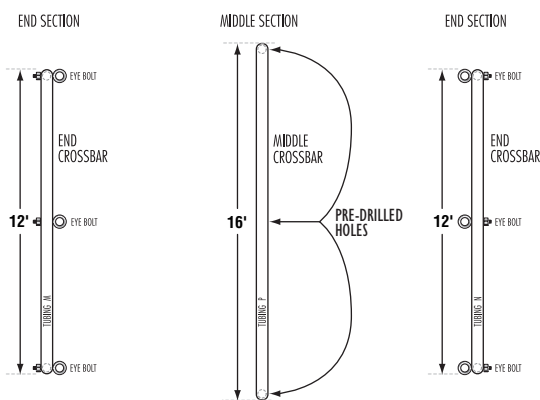

**4. FRONT VIEW OF END SECTIONS**

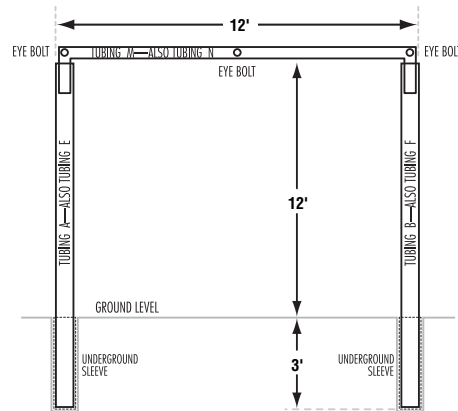

**5. FRONT VIEW OF MIDDLE SECTION**

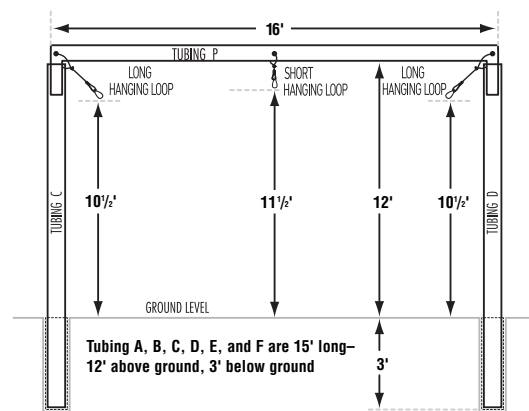

**6. TOP VIEW OF CABLES, EYE BOLTS, TURNBUCKLES ETC. IN PLACE**

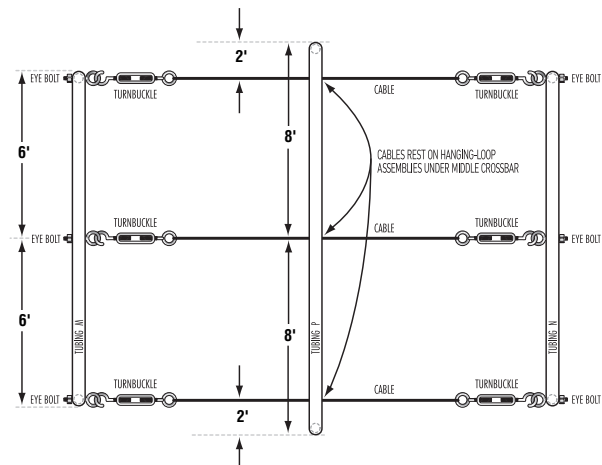

**7. DETAILS OF END CROSSBARS**

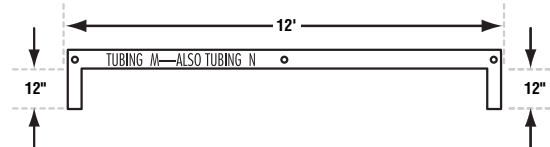

**8. DETAILS OF MIDDLE CROSSBAR**

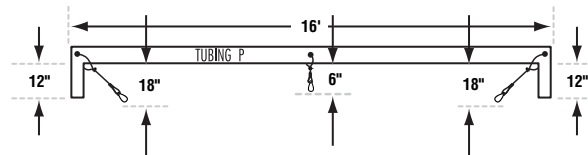

**9. OVERHEAD VIEW OF NET IN PLACE**

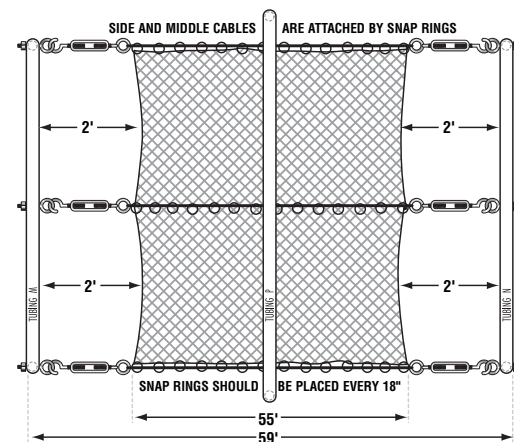

**10. SIDE VIEW OF NET IN PLACE**

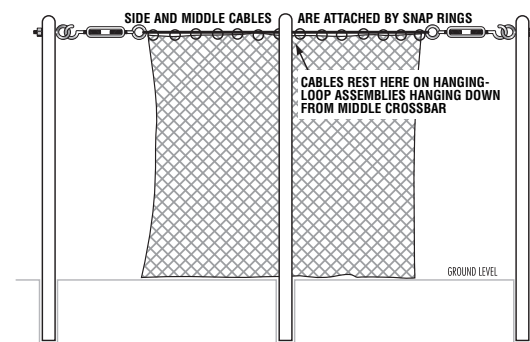

NOTE: Drawings are not to scale.

**HOW TO ATTACH YOUR NETTING TO THE CABLES**

1. The cables should be placed and tightened to your frame sections or walls.
2. Stretch out your net on the ground underneath the cables.
3. Starting at one end, while on a ladder or platform, have your partner hand up to you the end of the net.
4. Attach the rope border, on top of the net, to the cables by opening the snap rings and putting the rope and cable inside. Repeat this every 18", having your partner continue to “feed” you the net until one side is completed.
5. Repeat steps 3 and 4 for the middle and opposite side cable.

Note: You should have to go up and down the ladder only three times, once for each of the cables.

**HOW TO ATTACH YOUR CABLES TO THE EYE BOLTS**

1. Cut cable to appropriate length.
2. Run one end of your cable through the turnbuckle and secure using cable clamp. Tape end of cable to prevent fraying.
3. Hook turnbuckle on to eye bolt extending from the wall or frame section.
4. Repeat steps 2 and 3 at opposite end.
5. Tighten the turnbuckles at each end of the cable to provide tension to hold up the net.
6. Important: Tighten the cables so that they rest in cable hooks. (See diagrams #5 and #6.)  
Do not tighten cables any tighter or you will risk bending the pipes.

Note: You should provide for extra cable length when setting up initially. You can always cut off excess cable if not needed.

**Close-up view of the eye bolt, turnbuckle, cable clamp, cable, and snap rings assembled:**

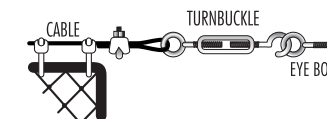

**HOW TO ATTACH YOUR HANGING LOOPS TO THE MIDDLE CROSSBAR**

1. Slide a cable clamp onto each of the three hanging-loop assemblies—two with longer cables and one with a shorter cable. You will attach the two longer ones near the ends of the crossbar and the shorter one at the center of the crossbar.
2. At each pre-drilled hole on the crossbar, hold the clamp and hanging-loop assembly with one hand and thread the cable through the pre-drilled hole with your other hand.
3. Wrap the cable around the crossbar and thread it back down into the cable clamp.
4. Slide the cable clamp up on the cable and tighten it, leaving one inch of cable hanging below.

**Close-up view of the hanging-loop assemblies attached to middle and corners of the middle crossbar:**

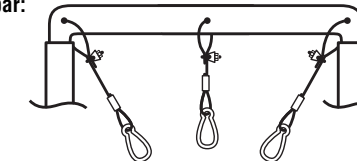

**CUSTOM NETTING** of all shapes and sizes now available, including: Batting Cage Nets, Backstops, Trapezoid Backstops, Outfield and Foul Ball Netting.

There are 3 Ways for you to get more information and FREE estimates on JUGS Custom Netting:

1. Call JUGS at 1-800-547-6843 and ask for a Net Specialist.
2. FAX your specifications to a Net Specialist at 503-691-1100.
3. E-mail your specifications to [jims@jugssports.com](mailto:jims@jugssports.com).

From factory to You in LESS THAN 2 WEEKS

**WARNING:** Do not leave your net and frame up during extreme weather conditions (high wind, snow), as non-warranty damage may occur.

[www.jugssports.com](http://www.jugssports.com)

JUGS Batting Cage Nets with 381 lb. or 691 lb. Breaking-Strength High-Tenacity Nylon Filaments are guaranteed for two (2) years against defects in material or workmanship. JUGS Batting Cage Nets with 119 lb. or 191 lb. Breaking-Strength High-Tenacity Nylon Filaments have a one (1) year guarantee against defects in material or workmanship. All JUGS Batting Cage Frames are guaranteed for five (5) years unless damaged by snow, ice or other acts of God. Commercial use of JUGS Batting Cage Nets or JUGS Batting Cage Frames automatically limits this warranty to thirty (30) days after date of shipment.